

GENERAL DESCRIPTION

The 1011GN-1200V is an internally matched, COMMON SOURCE, class AB, GaN on SiC HEMT transistor capable of providing over 18.5 dB gain, 1200 Watts of pulsed RF output power at 32us, 2% duty cycle pulse format across the 1030 to 1090 MHz band. The transistor has internal pre-match for optimal performance. It utilizes gold metallization and eutectic attach to provide highest reliability and superior ruggedness.

CASE OUTLINE 55-Q03 Common Source

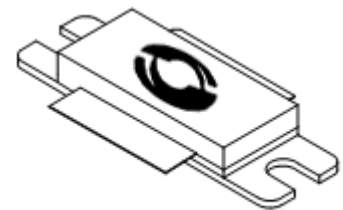

ABSOLUTE MAXIMUM RATINGS

Maximum Power Dissipation

Device Dissipation @ 25°C 2400W

Maximum Voltage and Current

Drain-Source Voltage (V_{DSS}) 150 V
Gate-Source Voltage (V_{GS}) -8 to +0 V

Maximum Temperatures

Storage Temperature (T_{STG}) -55 to +125° C
Operating Junction Temperature +200° C

ELECTRICAL CHARACTERISTICS @ 25°C

Symbol	Characteristics	Test Conditions	Min	Typ	Max	Units
P_{IN}	Input Power	$P_{OUT}=1200W$, Freq=1030,1090 MHz		10.5	15	W
G_P	Power Gain	$P_{OUT}=1200W$, Freq=1030,1090 MHz	18.5	20		dB
η_D	Drain Efficiency	$P_{OUT}=1200W$, Freq=1030,1090 MHz		75		%
Dr	Droop	$P_{OUT}=1200W$, Freq=1030,1090 MHz			0.3	dB
VSWR-T	Load Mismatch Tolerance	$P_{OUT}=1200W$, Freq= 1030MHz			3:1	
Θ_{JC}	Thermal Resistance	32us, 2% duty cycle			0.145	°C/W

- Bias Condition: $V_{DD}=+50V$, $I_{DQ}=150mA$ average current ($V_{GS}= -2.0 \sim -4.5V$ typical)

FUNCTIONAL CHARACTERISTICS @ 25°C

$I_{D(OFF)}$	Drain leakage current	$V_{GS} = -8V$, $V_D = 150V$			64	mA
$I_{G(OFF)}$	Gate leakage current	$V_{GS} = -8V$, $V_D = 0V$			20	mA

Export Classification: EAR 99



1011GN-1200V

1200 Watts • 50 Volts • 32us, 2%
L-Band Avionics 1030/1090 MHz

TYPICAL BROAD BAND PERFORMANCE DATA

1030 MHz				1090 MHz		
P _{IN} (W)	P _{OUT} (W)	IRL (dB)	Eff (%)	P _{OUT} (W)	IRL (dB)	Eff (%)
7.9	1045	-14	74	1220	-14	84
10.0	1200	-14	76	1330	-14	86
12.6	1330	-13	78	1360	-14	87
14.1	1390	-13	79	1350	-14	87

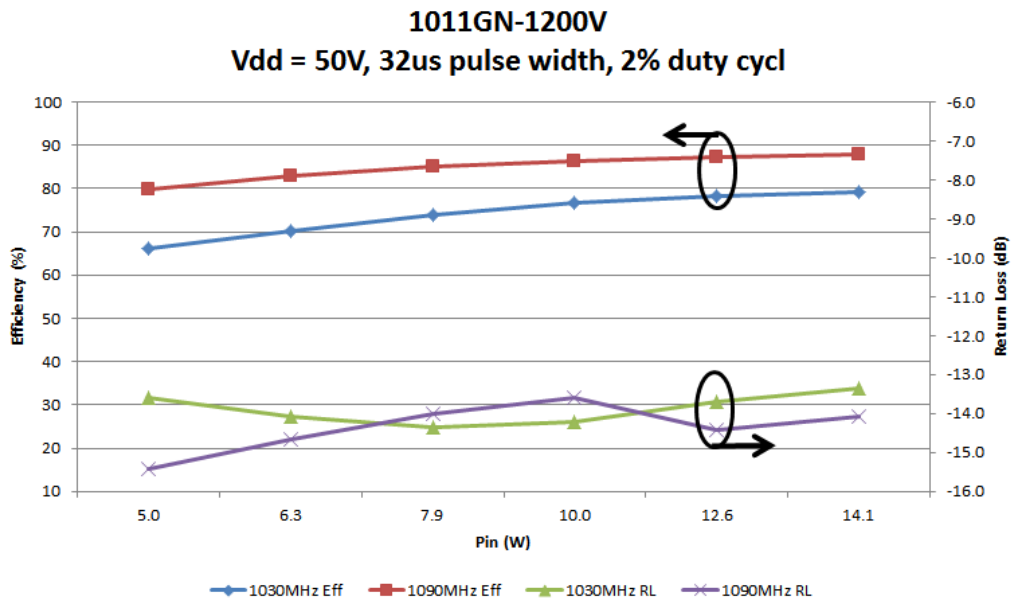
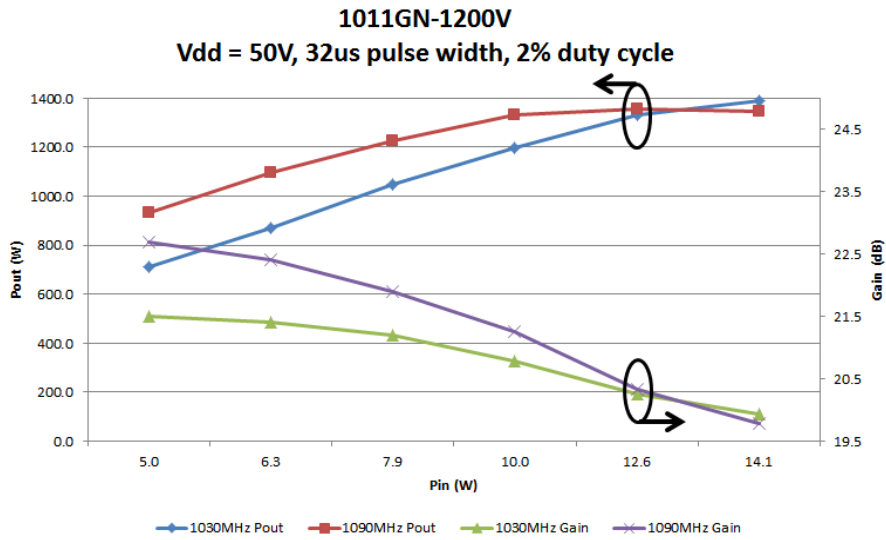



1011GN-1200V

1200 Watts • 50 Volts • 32us, 2%
L-Band Avionics 1030/1090 MHz

TYPICAL OVER TEMPERATURE PERFORMANCE

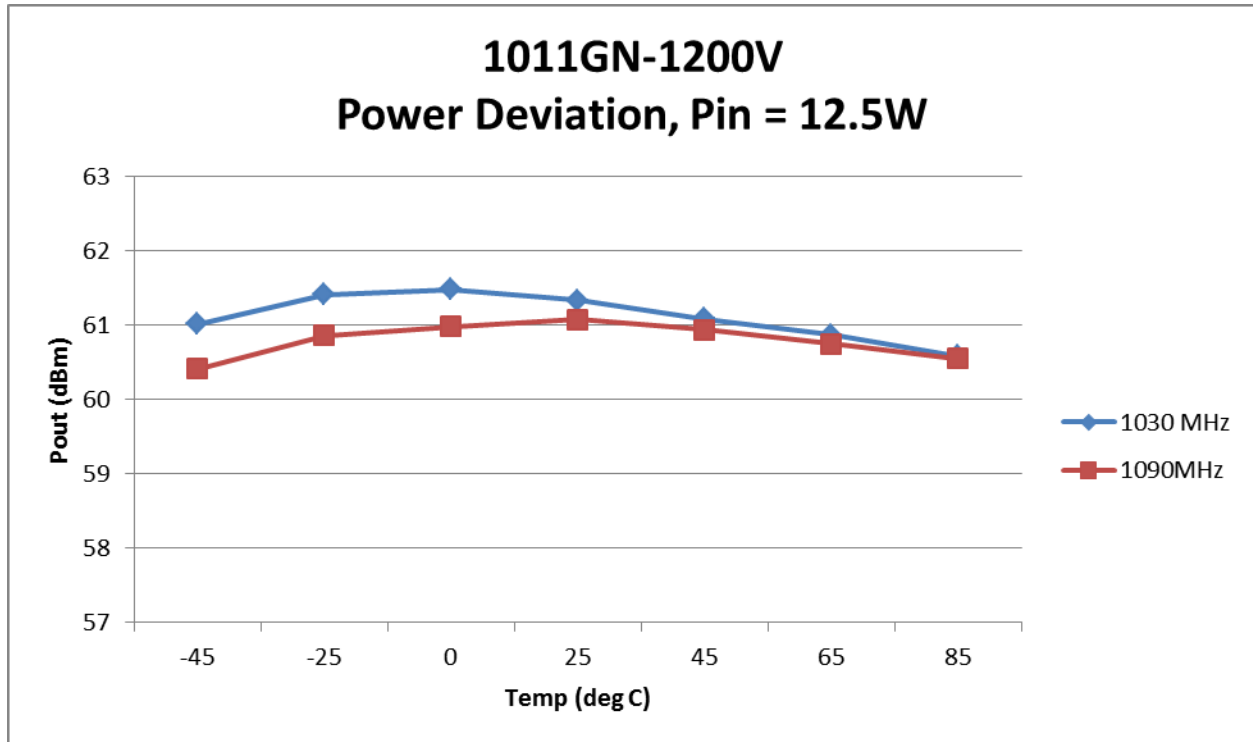

TRANSISTOR IMPEDANCE INFORMATION

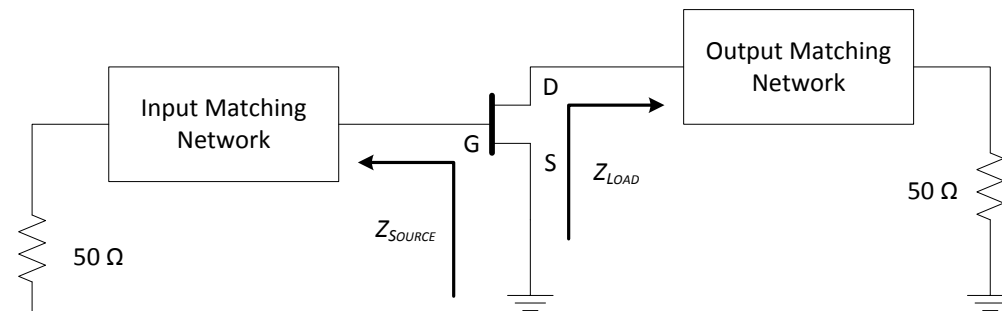

Note: Z_{SOURCE} is looking into the input circuit
 Z_{LOAD} is looking into the output circuit

Frequency	Z_{SOURCE}	Z_{LOAD}
1030 MHz	1.32-j0.37 Ω	0.86-j1.1 Ω
1060 MHz	1.38-j0.2 Ω	0.80-j0.94 Ω
1090 MHz	1.46-j0.08 Ω	0.74-j0.82 Ω

TEST CIRCUIT (inches)

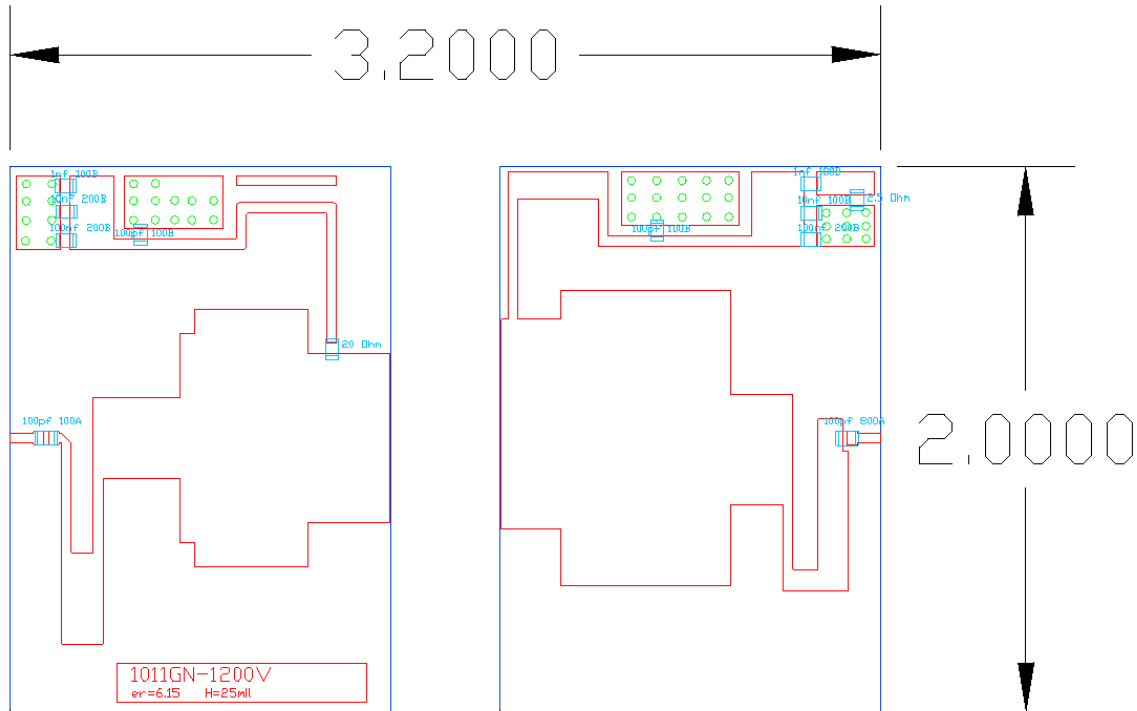

- **Board Material: Roger Duroid 6006 @ H=25 mils, Er=6.15**
- **DXF file available upon request**

BILL OF MATERIALS

Item	Description	Value
C1	ATC 100A	100pF
C2	ATC 800A	100pF
C3	ATC 100B	100pF
C4	ATC 100B	1nF
C5	ATC 200B	10nF
C6	ATC 200B	100nF
R1	0805	20Ω
R2	0805	2.5Ω



1011GN-1200V

1200 Watts • 50 Volts • 32us, 2%
L-Band Avionics 1030/1090 MHz

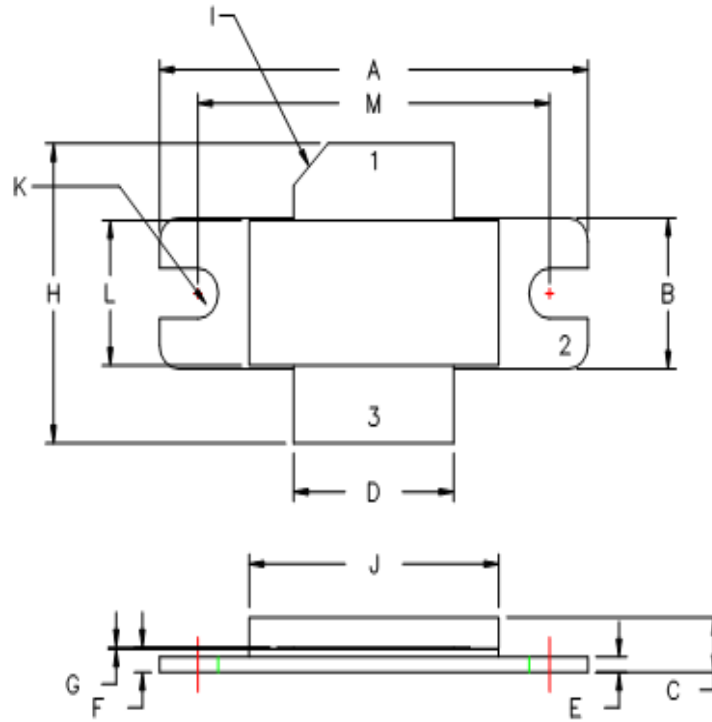

DIM	MILLIMETER	TOL	INCHES	TOL
A	34.03	.25	1.340	.010
B	9.78	.25	.385	.010
C	3.55	.19	.140	.007
D	12.70	.13	.500	.005
E	1.02	.13	.040	.005
F	1.65	.13	.065	.005
G	0.13	.03	.005	.001
H	19.43	.76	.765	.030
I	45°	5°	45°	5°
J	19.81	.25	.780	.030
K	3.30 DIA	.13	.130 DIA	.005
L	9.40	.13	.370	.005
M	27.94	MAX	1.100	MAX

PIN 1 = DRAIN
PIN 2 = SOURCE
PIN 3 = GATE



1011GN-1200V

1200 Watts • 50 Volts • 32us, 2%
L-Band Avionics 1030/1090 MHz

Microsemi makes no warranty, representation, or guarantee regarding the information contained herein or the suitability of its products and services for any particular purpose, nor does Microsemi assume any liability whatsoever arising out of the application or use of any product or circuit. The products sold hereunder and any other products sold by Microsemi have been subject to limited testing and should not be used in conjunction with mission-critical equipment or applications. Any performance specifications are believed to be reliable but are not verified, and Buyer must conduct and complete all performance and other testing of the products, alone and together with, or installed in, any end-products. Buyer shall not rely on any data and performance specifications or parameters provided by Microsemi. It is the Buyer's responsibility to independently determine suitability of any products and to test and verify the same. The information provided by Microsemi hereunder is provided "as is, where is" and with all faults, and the entire risk associated with such information is entirely with the Buyer. Microsemi does not grant, explicitly or implicitly, to any party any patent rights, licenses, or any other IP rights, whether with regard to such information itself or anything described by such information. Information provided in this document is proprietary to Microsemi, and Microsemi reserves the right to make any changes to the information in this document or to any products and services at any time without notice.

About Microsemi

Microsemi Corporation (Nasdaq: MSCC) offers a comprehensive portfolio of semiconductor and system solutions for communications, defense & security, aerospace and industrial markets. Products include high-performance and radiation-hardened analog mixed-signal integrated circuits, FPGAs, SoCs and ASICs; power management products; timing and synchronization devices and precise time solutions, setting the world's standard for time; voice processing devices; RF solutions; discrete components; enterprise storage and communication solutions, security technologies and scalable anti-tamper products; Ethernet solutions; Power-over-Ethernet ICs and midspans; as well as custom design capabilities and services. Microsemi is headquartered in Aliso Viejo, Calif., and has approximately 4,800 employees globally. Learn more at www.microsemi.com.

©2016 Microsemi Corporation. All rights reserved. Microsemi and the Microsemi logo are registered trademarks of Microsemi Corporation. All other trademarks and service marks are the property of their respective owners.

Microsemi Corporate Headquarters

One Enterprise, Aliso Viejo, CA 92656 USA
Within the USA: +1 (800) 713-4113
Outside the USA: +1 (949) 380-6100
Sales: +1 (949) 380-6136 Fax: +1 (949) 215-4996
E-mail: sales.support@microsemi.com

Revision History

Revision Level / Date	Para. Affected	Description
06/ March 20 2015	-	Initial Preliminary Release