

N Connectpr Straight Crimp Type Bulkhead Jack - Diecast Body

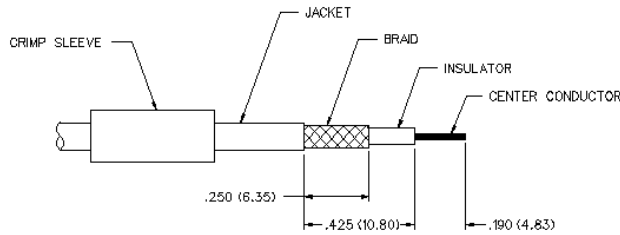

CABLE TYPE	NICKEL PLATED
RG-161/U, 174, 188, 316	134-0303-406

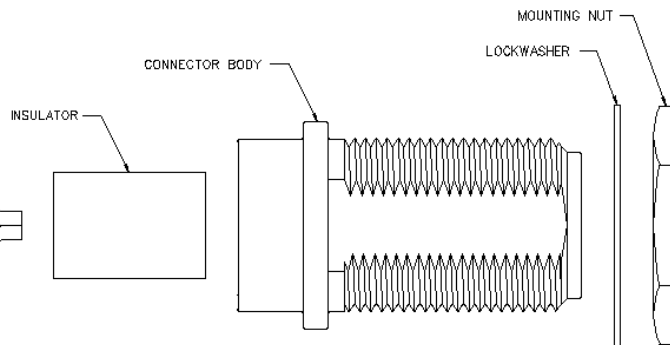
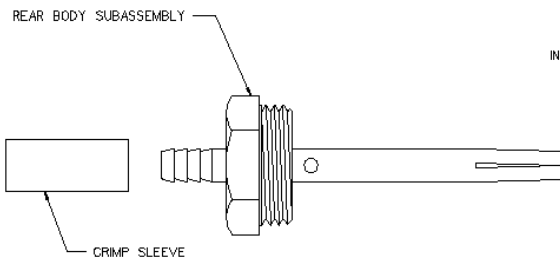
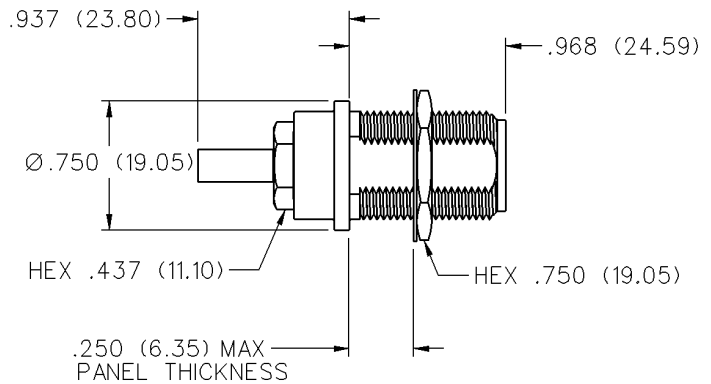

CABLE GROUP	PART NUMBER	CRIMP HEX
RG-316/u, 161, 174, 188	134-0303-406	.160 (4.06)

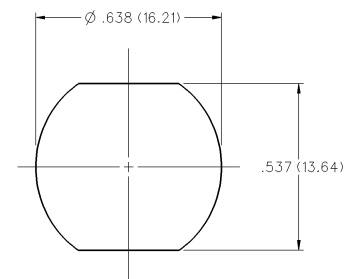
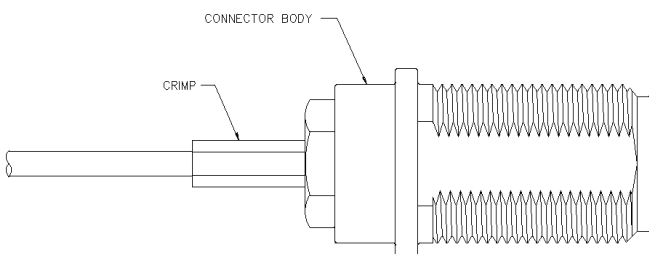
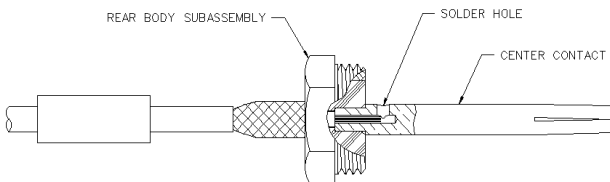

1. Identify connector parts. (6 piece parts)
2. Strip cable to dimensions shown. Do not nick braid or center conductor. A wire stripper of correct size is recommended for this step. Twist stranded center conductor into a tight bundle and tin (optional). Slide crimp sleeve onto cable as shown.
3. Flare body and slide cable into crimp stem of rear body subassembly, until cable dielectric bottoms out on center contact. Solder center conductor to contact through the solder hole. Solder must not be allowed to gather and run on outside of contact. Use a minimum amount of solder for a good joint. **.020 (0.51) diameter solder is recommended.**
4. Arrange braid uniformly around crimp stem. Slide crimp sleeve over braid and crimp securely using recommended crimp tool. Slide insulator over center conductor and slide center contact assembly into connector body. Thread rear body subassembly into body and tighten securely (ref. 30 in-lbs torque.)

N Connectors

Specifications

ELECTRICAL RATINGS

Impedance: 50 ohms

Frequency Range: 0-11 GHz

VSWR: (f = GHz)	Typical VSWR	Frequency Range (GHz)
RG-316 cable	1.20	0-2
	1.50	2-11
RG-58 cable	1.30	0-5
	1.70	5-11
RG-142 cable	1.20	0-5
	1.50	5-11

Working Voltage: (Vrms maximum)†

Connectors for Cable Type	Sea Level	70K Feet
RG-316	335	85
RG-58	500	125
RG-142	500	125

Dielectric Withstanding Voltage: (VRMS minimum at sea level)†

RG-316	1000
RG-58	1500
RG-142	1500

Insulation Resistance: 5000 megohms minimum

Contact Resistance: (milliohms maximum)

	Initial	After Environmental
Center contact	3.0	4.0
Outer contact	2.0	N/A
Braid to body	5.0	N/A

MECHANICAL RATINGS

Engagement Design: MIL-STD-348, series N

Engagement Force/Disengagement Force: 6 inch-pounds maximum

Mating Torque: 6 to 10 inch-pounds

Cable Retention: Axial Force(lbs)*

RG-316 20

RG-58 40

RG-142 45

* Or cable breaking strength whichever is less.

Durability: 500 cycles minimum

ENVIRONMENTAL RATINGS

(Meets or exceed the applicable paragraph of MIL-C-39012)

Temperature Range: - 65°C to + 165°C

Thermal Shock: MIL-STD-202, Method 107, Condition B

Corrosion: MIL-STD-202, Method 101, Condition B

Shock: MIL-STD-202, Method 213, Condition I

Vibration: MIL-STD-202, Method 204, Condition B

Moisture Resistance: MIL-STD-202, Method 106

MATERIAL SPECIFICATIONS

Bodies: Main body - zinc per ASTM B86-71, nickel plated per QQ-N-290

Rear body - brass per QQ-B-626, nickel plated per QQ-N-290

Contacts: Beryllium copper per QQ-C-530, gold plated** per MIL-G-45204, .00001" min.

Insulators: PTFE fluorocarbon per ASTM D 1710 and ASTM D 1457

Crimp Sleeves: Copper per WW-T-799, nickel plated per QQ-N-290

Mounting Hardware:

Nut - brass per QQ-B-626, nickel plated per QQ-N-290

Lockwasher - steel per QQ-S-700, zinc plated per QQ-Z-325

** All gold plated parts include a .00005" min. nickel underplate barrier layer.

† Avoid user injury due to misapplication.

See safety advisory definitions inside front cover.

MATING ENGAGEMENT FOR N SERIES PER MIL-C-39012

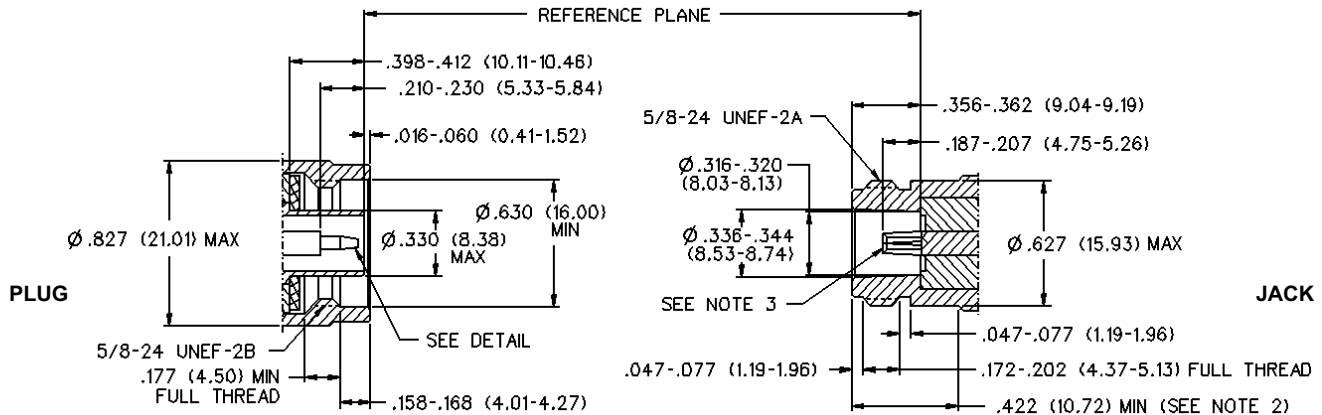

NOTES

1. This interface shall meet the gauge requirements as specified in MIL-C-39012/1/2
2. Clearance for mating connector coupling unit.
3. I.D. to meet VSWR. Contact resistance and insertion withdrawal forces when mated with a .063/.066 (1.60/1.68) diameter male pin.

SHAPE OF TIP OPTIONAL.
.010 (0.25) MAX FLAT PERMITTED.